



AFO LUX

# IEI AFOLUX Multimedia Monitor



## AFL-M Series

7"~19" AFOLUX Touch  
Monitor Series

NEW



## AFL-GM Series

7"~19" AFOLUX Tempered Glass  
Protection Monitor Series

**8H** Scratch  
Proof LCD



# Enrich Your Applications



## AFL-M Series

### Features:

- Touch system draws your customers in and keeps them involved and quickly control the system just by simple touch.
- Finger, gloved hand and stylus activation
- Optional USB/RS-232 interface(USB and RS-232 interfaces 2-in-1 for 7" to 12.1" AFOLUX monitors)

### Applications:

POS / KIOSK / ATM machine.

## A 7"~19" AFOLUX Touch Monitor Series

with durable 4/5-wire resistive touch screen



### Interactive Digital Signage

**4/5-wire resistive touch screen Interactive platform attracts people's** Interactive platform attracts people's attention. It draws your customers in and keeps them involved. Use it for product or service information, directories, check-in services and exhibit details so your customers have the information they need right at their fingertips .



## AFL-GM Series

### Features:

- Easy cleaning
- Scratch proof
- Surface anti-reflection treatment decreases glare and reflections and increases contrast
- Improved eye comfort
- High Transmission

### Applications:

Digital signage / Gaming / Betting / Check-In Terminal / Medical

## B 7"~19" AFOLUX Tempered Glass Protection Monitor Series

with high efficiency Anti-Reflection treatment

### Stronger Protection

IEI AFOLUX tempered glass monitor's 8H hardness through strict testing is stronger than the conventional panel and therefore is able to protect the screen from damage ,offers protection solutions for a wide variety of applications.

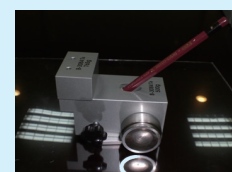

Hardness Test (JIS-K5600)



Abrasion Test (Steelwool #0000)

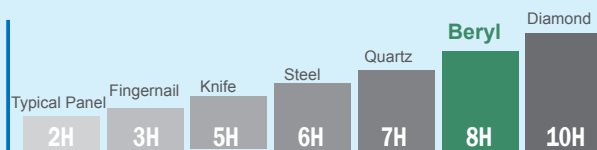

### Anti-reflection coated over the glass surface

AFOLUX tempered glass monitor series with special AR coating (anti-reflection) are specially engineered to reduce reflection and increase transmission of light to get better image.

### Easy Cleaning

AFOLUX tempered glass protection monitor series equipped with the tempered glass can be easily cleaned with water, alcohol or common cleaning solution without losing its optical characteristics and scratching the surface.

W/O AR Coating With AR Coating



- Reduced intensity of reflected light
- No image distortion
- Higher contrast
- Wider viewing angles
- Colors are more vibrant



- 8H Hardness
- Scratch proof
- Easy to clean
- Impact resistant

# AFOLUX Multimedia Monitor Features

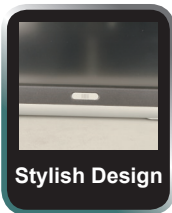

## Stylish Design

The clean and refreshingly simple looks of the AFOLUX monitors provide an aesthetic interface for public area applications (e.g. ATMs) and industrial solutions (e.g. operator terminal).



## Light Weight Construction

Light weight construction ensures the AFOLUX can be rack mounted, panel mounted and mounted on a VESA stand.

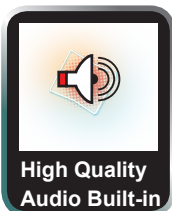
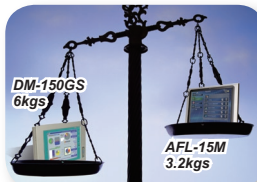

## High Quality Audio Built-in

Two built-in speakers deliver dual 1.5/3 watts sound for your multimedia enjoyment.



## 5 Video Inputs

The AFL-15M/17M/19M have multiple video inputs through common video connectors including VGA, DVI-D, S-Video, component and BNC video input interfaces.

The 5-in-1 system connects to a wide range of devices and most electronic appliances. (The AFL-07M/08M/10M/12M has a 4-in-1 system with VGA, S-Video, Component and Composite)

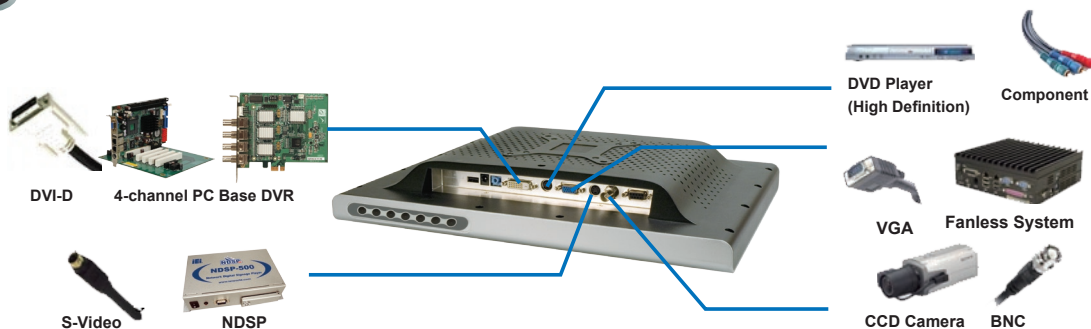

## 7"~12.1" AFOLUX Monitor

### 4-in-1 Multiple Video Input System

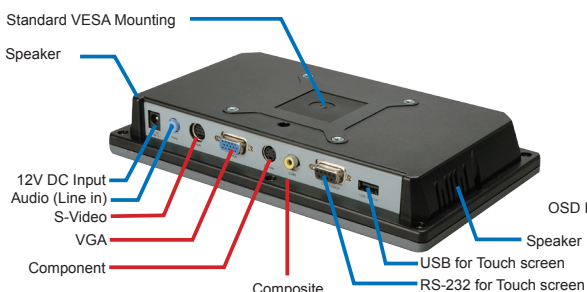

## 15"~19" AFOLUX

### 5-in-1 Multiple Video Input System (DVI-D Added)

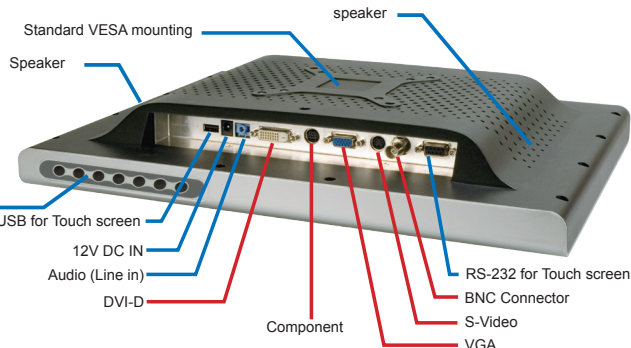



# AFOLUX Multimedia Monitor Features

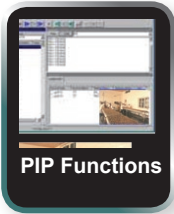

## PIP Functions

PIP enables a second video/image to be viewed in a small on-screen window. Images from other sources including DVR and DVD devices can also be viewed in the PIP window.

The small onscreen window can be easily resized and moved to a specified onscreen location. Alternatively, "picture-outside-picture" (POP) can be implemented by dividing the screen into two equally sized portions with two different outputs being displayed on either screen.

### PIP Settings :

- Three sizes including small, medium and large
- Four positions including upper left, lower left, upper right and lower right.
- Independent PIP widow color controls (brightness, contrast, hue and saturation)
- A blend function makes the PIP transparent



Picture In Picture (Video on Video)

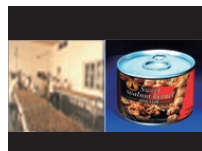

Side by Side (Video & Video)

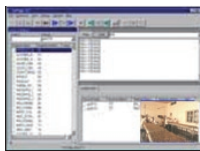

Picture In Picture (Video on Graphics)

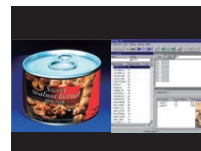

Side by Side (Video & Graphics)

Main screen and sub screen can't display BNC/S-Video or VGA/YPbPr inputs at the same time



## Full OSD Functions

Integrated OSD functions under the front panel enables convenient monitor configuration. Image, display ,PIP, color and system configurations can all be set with the hidden OSD.

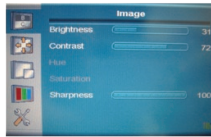

Image

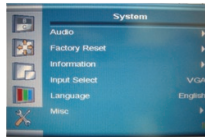

System



Color

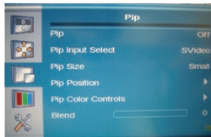

PIP



Display

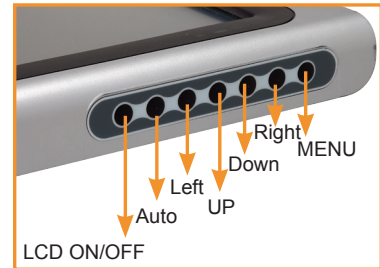

OSD Keypad is designed for AFL-15M/17M/19M



## Remote Control for OSD Functions

Hot-keys on the remote control include PIP zone, main source setting, auto-dimming, brightness, contrast and volume. Remote control hot-keys ensure easy configuration of the AFOLUX.

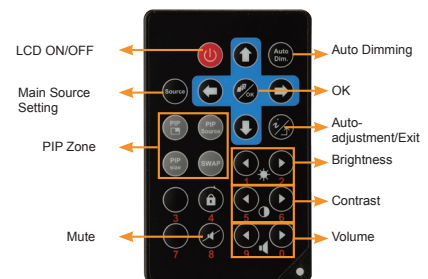

## Ambient Light Sensor

The AFOLUX 15M, 17M and 19M models with a mbient light sensor ensures your monitor performs optimally in all lighting conditions.

The ambient ALS can be turned on or off according to the users preference and the operational environment. Some of the AFL benefits include:

- Reduces cost of operation by reducing the power usage
- Extends backlight life
- Provides comfortable viewing



Higher Ambient Illuminance

Lower Ambient Illuminance

ALS is placed on the front side ,where there is an opening for light

# IEI smartOSD



## Software OSD for IEI LCD Monitors

IEI smartOSD is an intelligent and easy to use proprietary On-Screen-Display (OSD) software especially designed for IEI display monitors. It delivers excellent performance and flexibility over hardware OSD solution in the monitor unit. User can adjust monitor from smartOSD under Windows environment from the remote system instead of adjustment from front panel. The smartOSD allow you read and change such monitor settings as brightness, contrast, color and more enhanced features over normal video cable (VGA or DVI).

Note: The smartOSD function is only supported by revision 11 models and above

## Directly controls IEI display device through standard video cables !

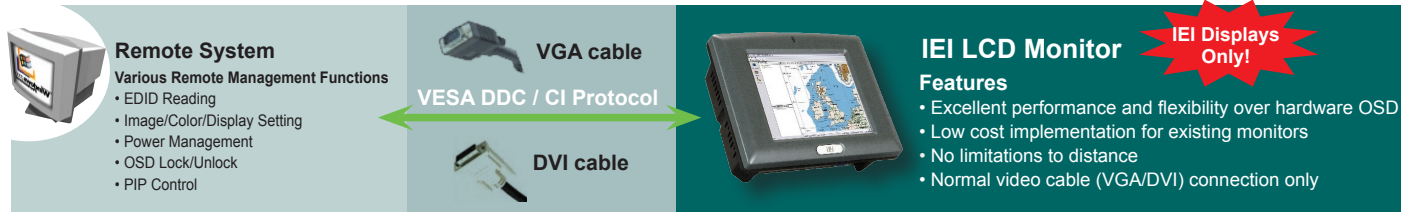

## Overcome Operation Obstacles

Distance, location and multiple display units no longer present any obstacles when controlling the monitors with the smartOSD.



Multiple Control Displays

Untouchable Location

## 100% Compatible With VESA DDC/CI Protocol

IEI LCD monitors are implemented with the VESA DDC/CI protocol and the standard VESA Monitor Control Command Set (MCCS). Compliance software for designing displays compatible with VESA's DDC/CI and MCCS standards are easily modified and applied in other application programs.

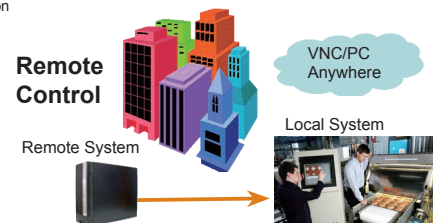

## Various Remote Management Functions

### 1. EDID

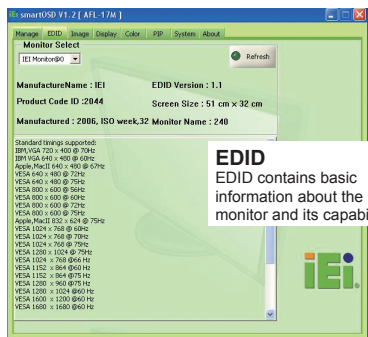

**EDID**  
 EDID contains basic information about the monitor and its capabilities

### 2. Image Setting

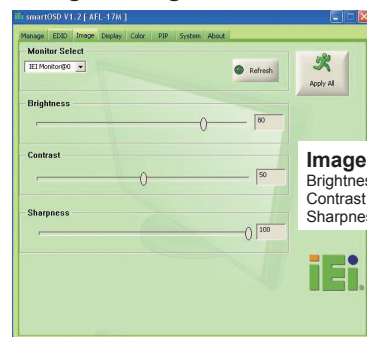

**Image**  
 Brightness  
 Contrast  
 Sharpness

### 3. Display Setting

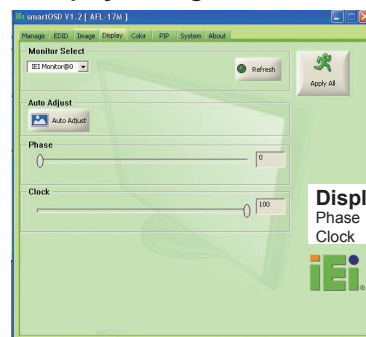

**Display**  
 Phase  
 Clock

### 4. Color Setting

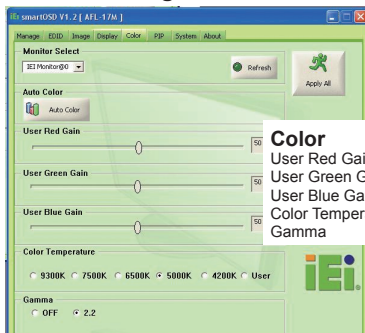

**Color**  
 User Red Gain  
 User Green Gain  
 User Blue Gain  
 Color Temperature  
 Gamma

### 5. Picture in Picture Setting



**PIP**  
 PIP On/Off  
 PIP Input Source  
 PIP Size

### 6. System Setting



**System**  
 Monitor Power Control  
 Auto Brightness  
 Main Source Input  
 Volume  
 Misc (Factory Reset/OSD Lock/ OSD Unlock)  
 Mute

## 7. Monitor Power Management and File Saving

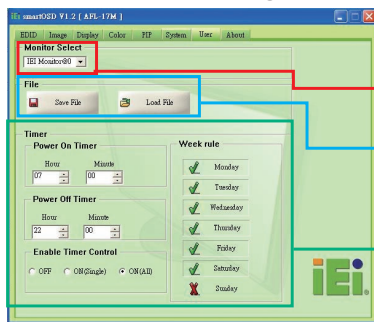

### Monitor Select

Selects the monitor unit for which the system parameters will be adjusted

### Settings Saving

Save the referred settings of all the OSD functions as .dat files and load the settings

### Power Management

Setting the monitor power on/off by time and week

## Valuable for Project Base

The smartOSD can be very useful in many projects:

### (1) Easy Configuration of Multiple Monitors

### (2) Fast Configuration of Multiple Monitors

Unlimited smartOSD setting configurations can be stored in the memory thereby enabling you to change or choose between memorized configuration modes more quickly.

### (3) Smart Power Management

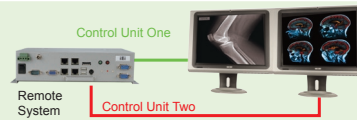

**Supermarket Daily Product Promotion**  
Different memorized settings enable you to easily configure your screen according to the promotion goods to deliver the greatest image to the viewers.



LCD monitor automatically turns on at 7 a.m. and turns off at 10 p.m. from Sunday to Monday

# AFOLUX Multimedia Touch Monitor

Advanced patented imaging technology on the AFOLUX LCD controller ensures the IEI AFOLUX has superior video quality.

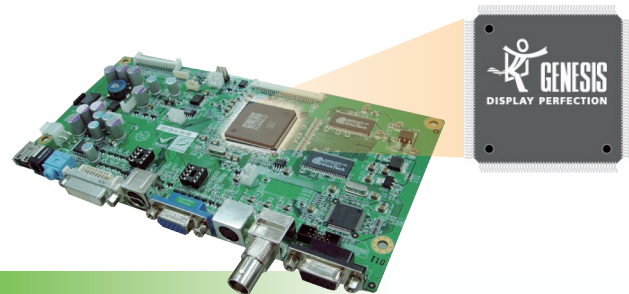

## Multi-function Touch Monitors

The AFOLUX multimedia touch monitors with the advanced LCD monitor controller supports resolutions up to and including WUXGA. The monitors are mid-range cost effective LCD TVs with PC and HDTV connectivity.

## High Definition Multi-function Touch Monitor

With VGA/YPbPr video input, the AFOLUX multimedia monitors can accept 1080i high resolution images.

Advanced patented imaging technology on the AFOLUX LCD controller includes Response Time Compensation (RTC) and Directional Correlation Deinterlacing (DCDi) and ensures the IEI AFOLUX has superior video image quality.

### Response Time Compensation

Motion blur in motion videos is prevented by RTC technology that enables the LCDs to respond as fast as CRTs.

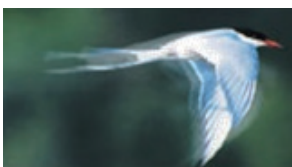

Without RTC



With RTC

### DCDi Technology

Jagged edges on diagonal lines caused by interpolation are eliminated with the DCDi video mode algorithm.



Without DCDi



With DCDi

# Superior Image Quality-Testing

## IEI Color Adjustment

Panel manufacturing processes may cause inconsistencies in an LCDs image quality. To ensure each panel produced has consistent image quality, each panel is tested by IEI's unique color adjustment system based on gamma curve, gray balance, and white balance measurement standards.



Color Adjustment Dark Room

## GAMMA Curve Adjustment

If a display device does not have the proper gamma response, the picture will be less than satisfactory. If the gamma is too low, the picture will have too much contrast and will lose detail. If it is too high, the picture will be washed out.

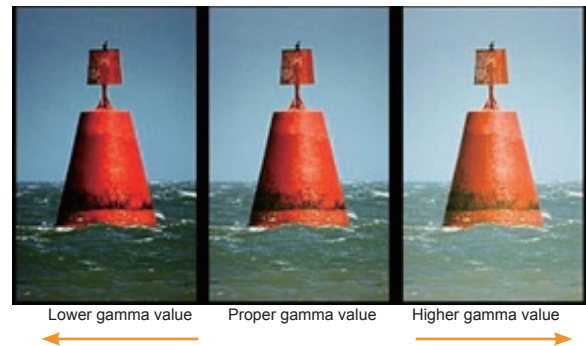

# Industrial Grade Compliance

## Industrial Grade Compliance

### IP 64 Compliant

The IP 64 compliant AFL-xxM series front panel guarantees the highest level of ingress protection against dust and low pressure water spray. The AFOLUX monitors can withstand any industrial environment where dust and drizzle is encountered.

### RS-232 or USB Touch Panel

AFL-xxM series supports 4/5 wire resistive touch screen via an RS-232 or a USB interface. The optional touch panel can withstand the demanding requirements of harsh industrial environments and outdoor applications such as POS, kiosks, retail, transportation, gaming, and surveillance.

### The touch panel with PIP assists production management



VGA Main Source-Production Management Software  
BNC Second Source-Surveillance Image

# Industrial Grade Compliance

## VESA Mounting Standards

The AFOLUX monitor series has four mounting holes compliant with the VESA mounting standard (75mm x 75mm/100mm x 100mm) on the rear panel for stand mounting and other mounting methods.

### V-Stand - VESA Standard multi-mounting stand

IEI patented multi-mounting V-Stand allows 0° to 90° adjustable Wall/Ceiling/Desk/Rear/Side mounting to meet diverse applications, mounting on kitchen, room and shelf.

- Features:
- 0° to 90° adjustable hinge design allows comfortable viewing
  - Standard VESA 75/100 Compliance
  - Heat dissipation holes designed
  - Compact size easy to use and mount anywhere



**C** 0° to 90° adjustable hinge design

**B** Designed holes help to dissipate the system heat

**A** VESA 75/100 Compliant with Height Adjustable

### D 5.6" ~ 12.1" AFOLUX PPC/Monitor Compatible

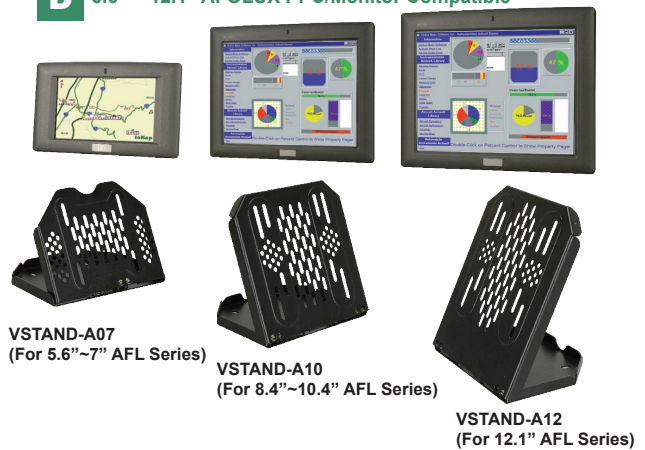

VSTAND-A07 (For 5.6"~7" AFL Series)

VSTAND-A10 (For 8.4"~10.4" AFL Series)

VSTAND-A12 (For 12.1" AFL Series)

## The Benefits~

### A. One fits all solution

V-Stand is designed around compact and tilt adjustable. Providing mobility and ergonomic comfort fits common wall mounting and ceiling mounting situations.



### B. 0° to 90° Excellent adjustability

you can change the angle of the stand from 0° to 90° to reach almost any point with ergonomic features for comfortable viewing.

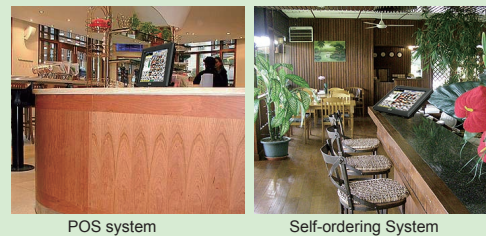

### C. Space saving and easy to install



1: Tighten the screws in the rear of the AFOLUX PPC VESA mounting holes



2: Select the position to mount stand kit



3: Plug in the system to operate

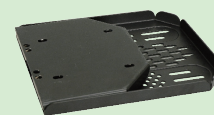

Compact size provides mobility



## Stand KIT

### Easy Stand

STAND-A08 (for 7" and 8.4") (Support up to 5 kg)

STAND-A12 (for 10.4" and 12.1") (Support up to 5 kg)

STAND-A19 (for 15" ,17" and 19") (Support up to 7.5 kg)



STAND-A08



STAND-A12



STAND-A19



Forward & Back Tilt

### Comfortable Stand

STAND-B19 (for 15",17" and 19")

(Support up to 7.3 kg)



STAND-B19



Height Adjustment(13 cm)



Right/Left Pan (270°)



Portrait/Landscape

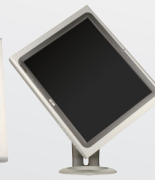

Forward & Back Tilt(+25°/-5°)

## Panel mount kits



## Wall mount kits

AFLWK-12

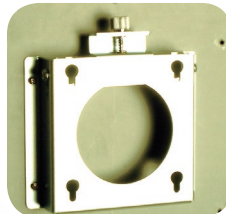

AFLWK-19

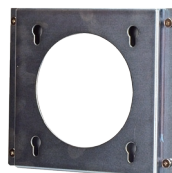

# Specifications



Model	AFL-07M/GM	AFL-08MH/GMH	AFL-10M/GM	AFL-12M/GM	AFL-15M/GM	AFL-17M/GM	AFL-19M/GM
Display Size	7"	8.4"	10.4"	12.1"	15"	17"	19"
Max Resolution	800 x 480 (WVGA)	800 x 600 (SVGA)	1024 x 768 (XGA)	1024 x 768 (XGA)	1024 x 768 (XGA)	1280 x 1024 (SXGA)	1280 x 1024 (SXGA)
Brightness (cd/m <sup>2</sup> )	350	450	400	450	350	300	300
Contrast Ratio	400:1	500:1	1200:1	700:1	400:1	800:1	800:1
LCD Color	262K	262K	16.2M	262K	262K	16.7M	16.7M
Pixel Pitch (mm)	0.1905(H) x 0.1905(V)	0.213(H) x 0.213(V)	0.0685(H) x 0.2055(V)	0.240(H) x 0.240(V)	0.297(H) x 0.297(V)	0.264(H) x 0.264(V)	0.294(H) x 0.294(V)
Viewing Angle (H/V)	140°/100°	120°/100°	160°/160°	160°/160°	120°/100°	160°/160°	
Backlight MTBF (Hrs)	30000	50000					
Input Video Signal Connector	1. Composite (NTSC/PAL) 2. YPbPr 3. S-Video 4. VGA				1. BNC Connector (NTSC/PAL) 2. YPbPr 3. S-Video 4. VGA 5. DVI		
Audio In	AMP 1.5W + AMP 1.5W (internal speaker)					AMP 3W + AMP 3W (internal speaker)	
Extension	IR Sensor (Remote Control)				1. Ambient Light Sensor 2. IR Sensor (Remote Control)		
Construction Front Panel	ABS and PC Plastic front frame						
Construction Chassis	Aluminum Chassis						
Power Adapter	36W				60W		
On Screen Display (OSD)	Remote Control for OSD Functions				1. OSD Keypad below the Front Panel 2. Remote Control for OSD Functions		
User's Controls	Image (Brightness, Contrast, Sharpness), Display (Auto Adjust, Phase, Clock, Display Control) PIP (Pip On/Off, Pip Input Select, Pip Size, Pip Position, Pip Color Controls, Blend) Color (Auto Color, Color Temperature, sRGB) System (Audio, Factory Reset, Information, Input select, Misc)				<b>OSD Buttons: Power, Left, Up, Down, Right, Menu</b> OSD: Image (Brightness, Contrast, Sharpness), Display (Auto Adjust, Phase, Clock, Display Control) PIP (Pip On/Off, Pip Input Select, Pip Size, Pip Position, Pip Color Controls, Blend) Color (Auto Color, Color Temperature, sRGB) System (Audio, Factory Reset, Information, Input select, Misc)		
Mounting	Panel / Wall mounting (VESA 75 x 75mm)		Panel / Wall mounting (VESA 75 x 75mm / 100 x 100mm)		Wall mounting (VESA 100 x 100mm)		
Dimension (WxHxD) (mm)	226 x 140 x 40.18	233.86 x 183.86 x 41.09	276 x 227 x 50.7	304 x 246 x 49.5	393.06 x 308.06 x 61	428 x 350 x 65	469.94 x 382.46 x 67
Operation Temperature (°C)	0~+50°C						
Net Weight (Kg)	0.88	1.14	1.33	2.12	3.2	5.0	5.6
Front Panel Protection	IP 64 Compliant						

## Options

	AFL-07M/GM	AFL-08MH/GM	AFL-10M/GM	AFL-12M/GM	AFL-15M/GM	AFL-17M/GM	AFL-19M/GM
Panel Mounting kits	AFLPK-08		AFLPK-12		AFLPK-15	AFLPK-17	AFLPK-19
Wall Mounting kits	AFLWK-12						AFLWK-19
Rack Mounting Kits	AFLRK-07	AFLRK-08	AFLRK-10	AFLRK-12	AFLRK-15	AFLRK-17	N/A
LCD Monitor Stand	STAND-A08/STAND-100-RS/STAND-150-RS		STAND-A12/STAND-100-RS/STAND-150-RS		STAND-A19/STAND-B19/STAND-210-RS		
VSTAND	VSTAND-A07	VSTAND-A10		VSTAND-A12	N/A		
DC to DC converter module	IDD-930160-KIT						

## Packing List

Item	Part No.	Remark
Power Cord	32000-000002-RS	Length:180cm
VGA Cable	32000-036200-RS	Length:180cm
Audio Cable	32000-036500-RS	Length:180cm
Component Cable	32000-083700-RS	Length:10cm
Component Extend Cable	32000-088100-RS	Length:170cm
DVI Cable	32000-086600-RS	Length:180cm for AFL-15M / 17M / 19M
36W Power Adapter	63000-FSP0361AD101C-RS	for AFL-07M / 08M / 10M / 12M
60W Power Adapter	63000-FSP0601AD101C-RS	for AFL-15M / 17M / 19M
User's Manual CD-ROM	7B000-000087-RS	
Remote Control	7Z000-8T00322ICP01G-RS	
Touch Pen	XTR104-0002-RS	for Touch Screen Models
Touch Screen RS-232 Cable	32000-000098-RS	Length:180cm for Touch Screen Models
Touch screen USB cable	32000-045801-RS	Length: 150cm for touch screen models



## Optional 60W DC/DC Converter Module Spec (P/N:IDD-930160-KIT)

Input Voltage	9~30VDC
Input Current	Max. 8A at 6VDC
Output	12V@5A
Max. Total Output	60W
Performance Characteristics	Noise & ±Ripple:<320mV, Line Regulation: <120mV, Load Regulation: <120mV
Transient toggle rate	250Hz (50% duty ratio)
Transient current step	From 0% to 50% and 50% to 100% of max current
Efficiency	typ. 95% (Vin=12V, 80% of full load)
Dimensions	42mm x 103mm x 31mm
Mounting Kit	12mm x 80mm
Cable Length	180cm
Operating Temperature	-40°C~85°C

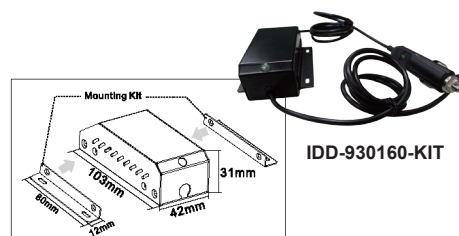

60 W DC/DC converter module can be easily mounted in the vehicle equipment to supply DC power source.

## Ordering Information

### AFO LUX Touch Monitor Series

Part NO	Description
AFL-07M/T-R-R11	7" 350cd/m <sup>2</sup> WVGA LCD monitor, plastic front panel, gray color, with 7" RS-232 and USB touch screen, RoHS
AFL-08MH/T-R-R11	8.4" 450cd/m <sup>2</sup> SVGA LCD monitor, plastic front panel, gray color, with 8.4" RS-232 and USB touch screen, RoHS
AFL-10M/T-R-R11	10.4" 400cd/m <sup>2</sup> SVGA LCD monitor, plastic front panel, gray color, with 10.4" RS-232 and USB touch screen, RoHS
AFL-12M/T-R-R11	12.1" 450cd/m <sup>2</sup> XGA LCD monitor, plastic front panel, gray color, with 12.1" RS-232 and USB touch screen, RoHS
AFL-15M/T-R-R11	15" 350cd/m <sup>2</sup> XGA LCD monitor, plastic front panel, gray color, with 15" RS-232 touch screen, RoHS
AFL-15M-USB/T-R-R11	15" 350cd/m <sup>2</sup> XGA LCD monitor, plastic front panel, gray color, with 15" USB touch screen, RoHS
AFL-17M/T-R-R11	17" 300cd/m <sup>2</sup> SXGA LCD monitor, plastic front panel, gray color, with 17" RS-232 touch screen, RoHS
AFL-17M-USB/T-R-R11	17" 300cd/m <sup>2</sup> SXGA LCD monitor, plastic front panel, gray color, with 17" USB touch screen, RoHS
AFL-19M/T-R-R11	19" 300cd/m <sup>2</sup> SXGA LCD monitor, plastic front panel, gray color, with 19" RS-232 touch screen, RoHS
AFL-19M-USB/T-R-R11	19" 300cd/m <sup>2</sup> SXGA LCD monitor, plastic front panel, gray color, with 19" USB touch screen, RoHS

### NEW AFO LUX Tempered Glass Protection LCD Monitor Series

Part NO	Description
AFL-07GM-R10	7" 350cd/m <sup>2</sup> WVGA LCD monitor, plastic front panel, gray color, with tempered glass protection, RoHS
AFL-08GMH-R10	8.4" 450cd/m <sup>2</sup> SVGA LCD monitor, plastic front panel, gray color, with tempered glass protection, RoHS
AFL-10GM-R10	10.4" 400cd/m <sup>2</sup> SVGA LCD monitor, plastic front panel, gray color, with tempered glass protection, RoHS
AFL-12GM-R10	12.1" 450cd/m <sup>2</sup> XGA LCD monitor, plastic front panel, gray color, with tempered glass protection, RoHS
AFL-15GM-R10	15" 350cd/m <sup>2</sup> XGA LCD monitor, plastic front panel, gray color, with tempered glass protection, RoHS
AFL-17GM-R10	17" 300cd/m <sup>2</sup> SXGA LCD monitor, plastic front panel, gray color, with tempered glass protection, RoHS
AFL-19GM-R10	19" 300cd/m <sup>2</sup> SXGA LCD monitor, plastic front panel, gray color, with tempered glass protection, RoHS



# Dimensions

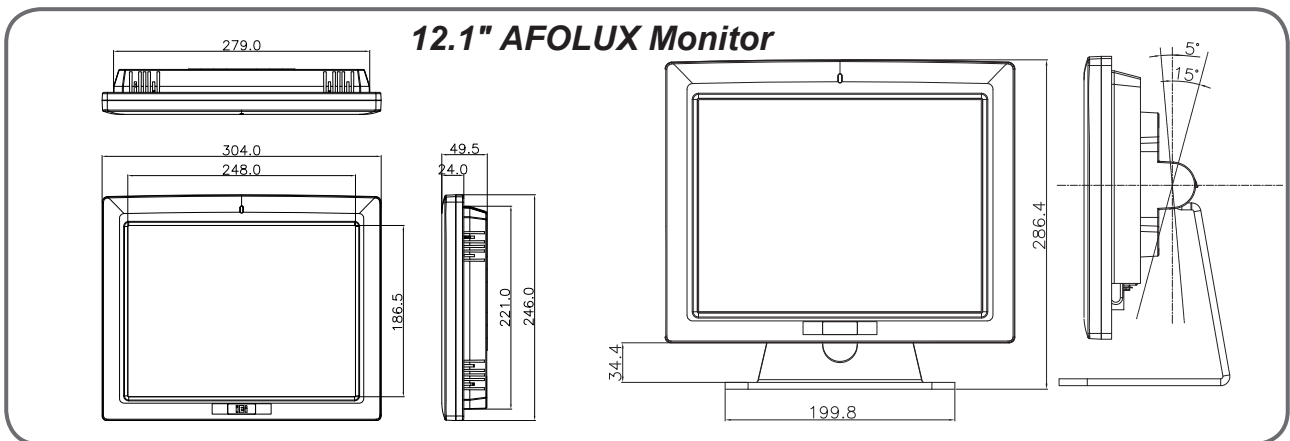
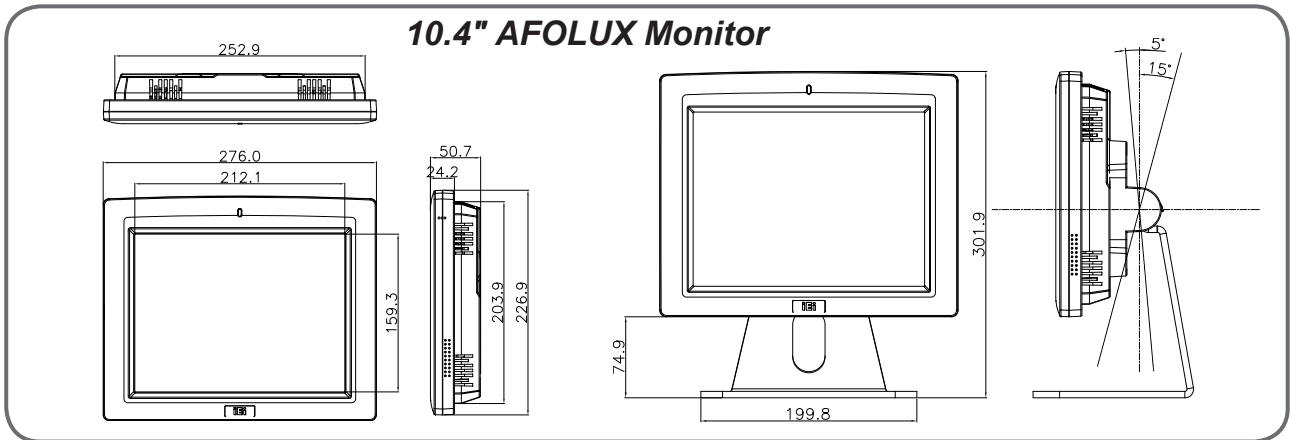
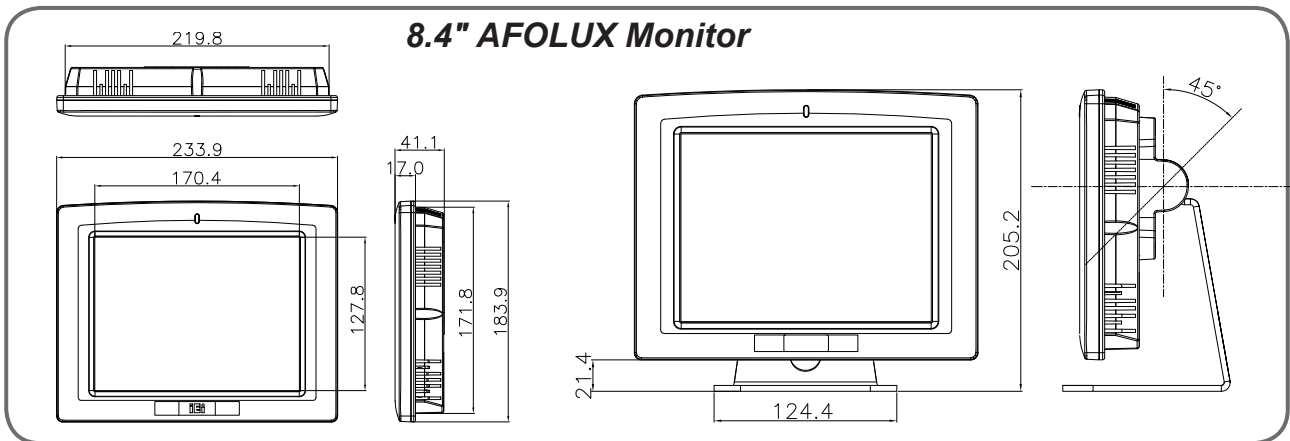
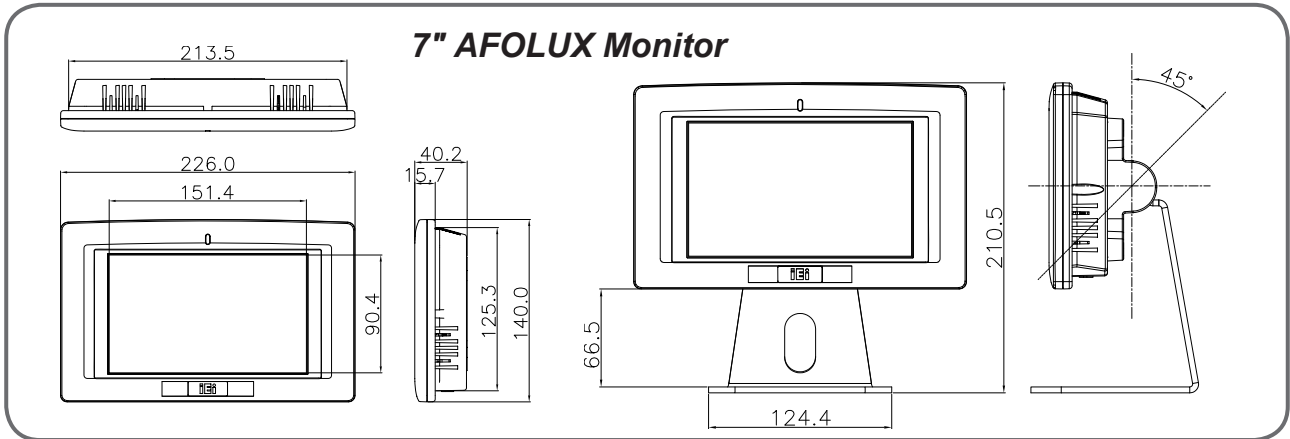

**15" AFOLUX Monitor**

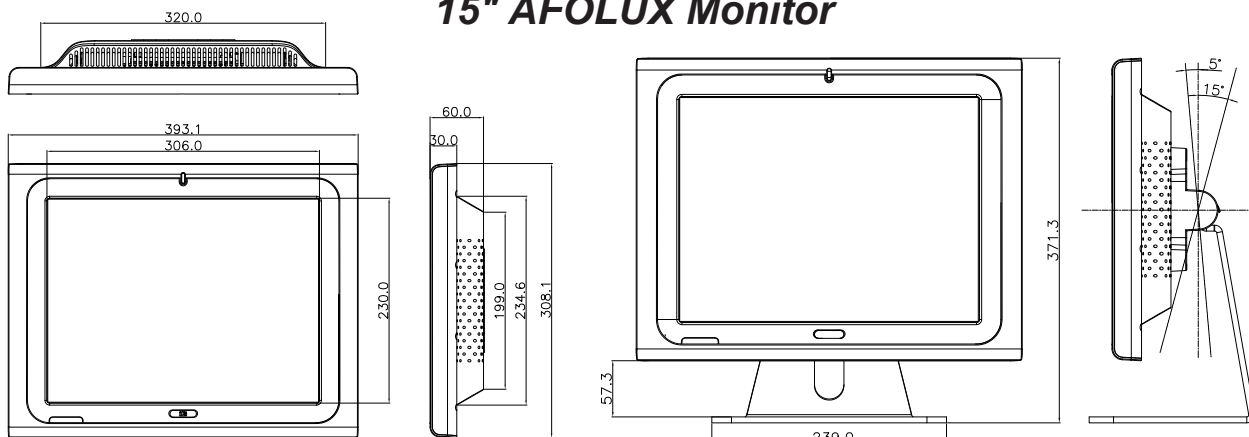

**17" AFOLUX Monitor**

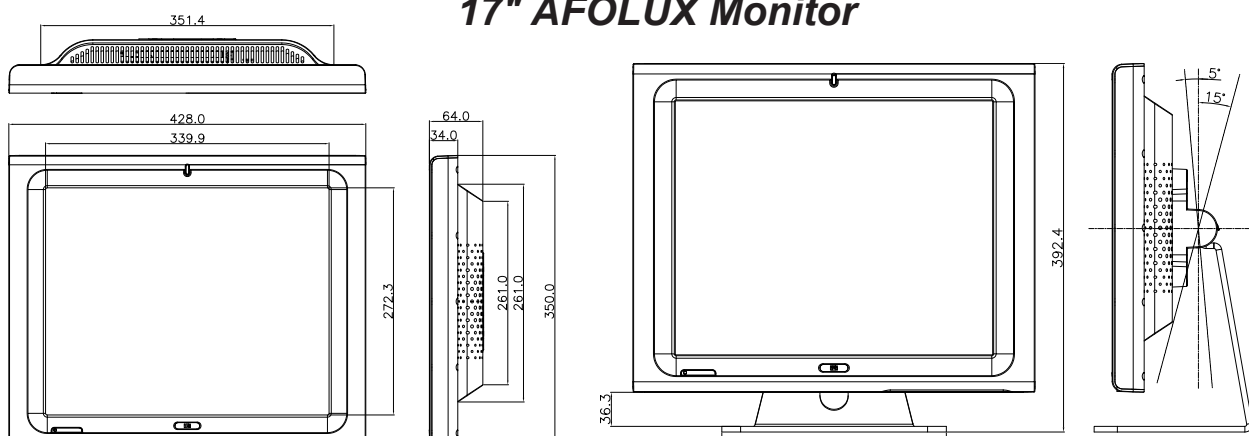

**19" AFOLUX Monitor**

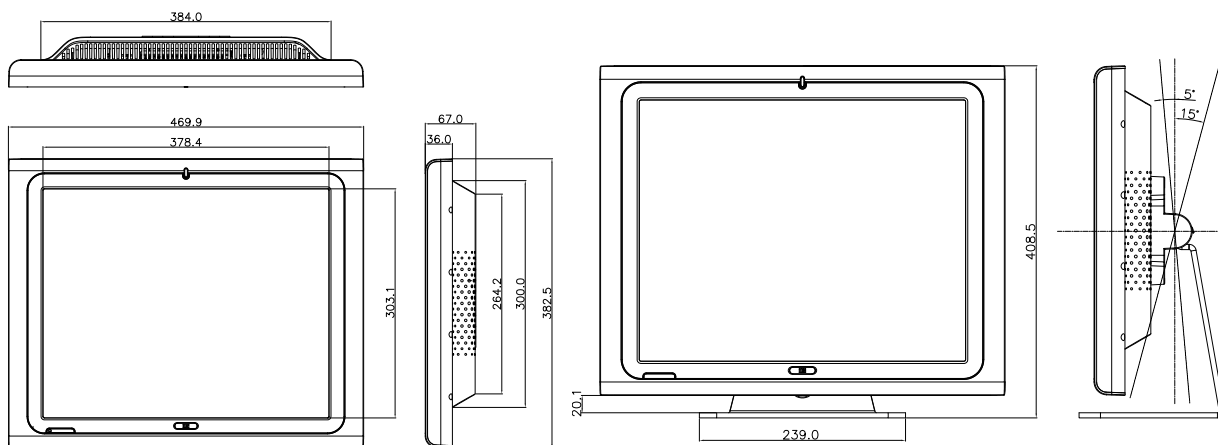



## AFL-GM Series



## AFL-M Series



### Headquarters

威強工業電腦股份有限公司 IEI Technology Corp.  
No. 29, Jhongsing Rd., Sijih City, Taipei County, 221, Taiwan  
TEL : +886-2-86916798 FAX : +886-2-66160028  
sales@ieiworld.com www.ieiworld.com

### America

IEI Technology USA Corp.  
168 University Parkway, Pomona, CA 91768  
TEL : +1-909-595-2819 FAX : +1-909-595-2816  
sales@usa.ieiworld.com www.usa.ieiworld.com

### China

威強工業電腦 IEI Technology (Shanghai) Co., Ltd.  
上海市闵行区宜山路 1728 号 3 楼.  
3F No. 1728 Yi-Shan Road, Min-Hang, ShangHai, China  
TEL : +86-21-3462-7799 FAX : +86-21-3462-7798,3462-7797  
sales@ieiworld.com.cn www.ieiworld.com.cn